



[qua]  
[dra]  
[2]  
sotuboi+d

O cenário ideal, que domina o espaço onde as ideias e a inovação surgem, enquanto exemplo de trabalho em espaços diferenciados.

Histórias de um espaço e de quem nele usufrui conforto, no ambiente de estudo ou de trabalho, entre concentração e pausas relaxantes.

El escenario ideal, que domina el espacio donde las ideas y la innovación surgen, como ejemplo de trabajo en espacios distintos.

Historias de un espacio y de quien en el disfruta del confort, en el ambiente de estudio o de trabajo, entre concentración y pausas relajantes.

La scène idéale, qui domine l'espace où l'idée et l'innovation jaillissent, comme exemple de travail dans des espaces différenciés.

Histoires d'un espace et de celui qui savoure son confort, dans une ambiance d'étude ou de travail, entre concentration et pauses relaxantes.

It is the ideal scenario, dominating the space where ideas and innovation emerge, as an example of work in differentiated spaces.

Stories of a space and of those who find in it the comfort, whether in the study or work environment, between concentration and relaxing breaks.

qua  
dra 2

A personalidade de um escritório é o reflexo do seu utilizador. A simplicidade alia-se ao conforto e o espaço respira uma atmosfera liberta de obstáculos, entregue às linhas funcionais e à ergonomia que reforça os argumentos para que se sinta realmente bem!

La personalidad de un despacho es el reflejo de su usuario. La simplicidad aliada al confort, en un espacio donde se respira una atmósfera libre de obstáculos, entregue a las líneas funcionales y a la ergonomía, que refuerzan los argumentos para que se sienta realmente bien!

La personnalité d'un bureau est le reflet de son utilisateur. La simplicité alliée au confort, dans un espace où l'on respire une atmosphère libérée des obstacles, soumise à des lignes fonctionnelles et à l'ergonomie, renforce les raisons de se sentir réellement bien!

The personality of an office is the reflection of its user. Simplicity meets comfort and the space breathes an obstacle-free atmosphere which, with its functional and ergonomic lines, reinforces the arguments to feel really good!









qua  
dra 2



qua  
dra 2



Armários com formas que se convertem e adaptam às funções para as quais estão destinadas. Apresentamos soluções efectivas, práticas e duradouras, convertendo espaços, segundo regras de funcionalidade definidas pelo utilizador.

Armarios con formas que se convierten y adaptan a las funciones para las que están destinadas. Presentamos soluciones efectivas, prácticas y duraderas, convirtiendo espacios, según reglas de funcionalidad definidas por el usuario.

La forme de nos meubles de bureaux permet par leur modularité une adaptation parfaite à ce pour quoi il sont destinés. Nous proposons des solutions efficaces, pratiques et résistantes, qui façonnent les espaces au gré des règles fixées par l'utilisateur.

The cabinet's shapes enable the conversion and adaptation to the functions for which they are intended. We present effective, practical and durable solutions, converting spaces according to rules of functionality determined by the user.



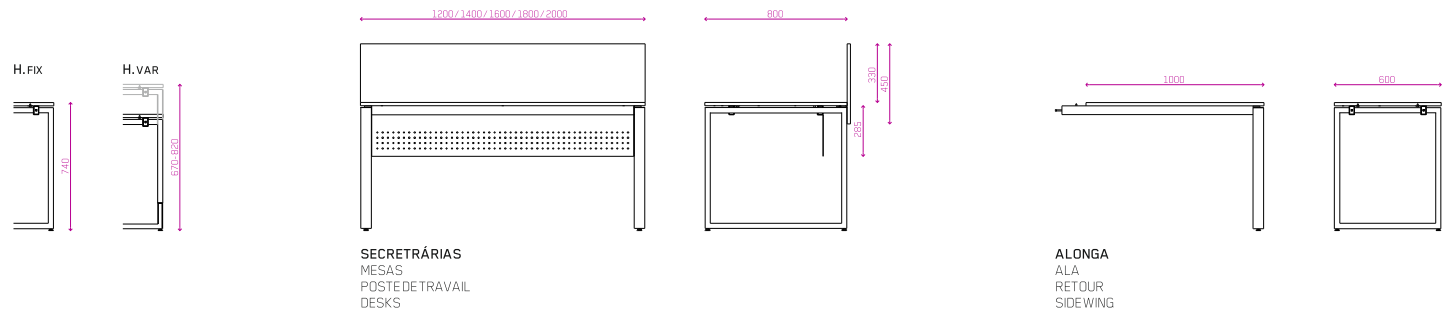

**SECRETRÁRIAS**  
MESAS  
POSTE DE TRAVAIL  
DESKS

**ALONGA**  
ALA  
RETOUR  
SIDEWING

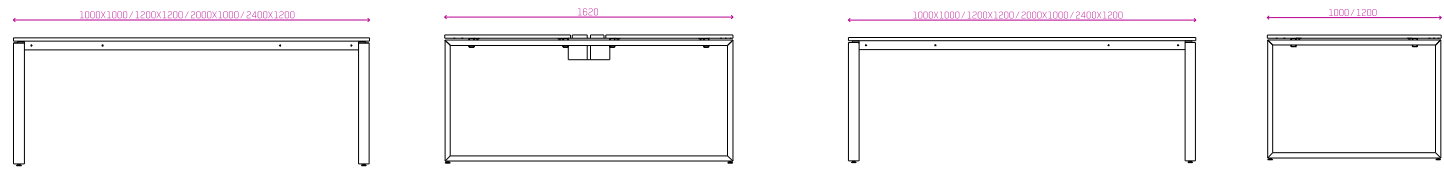

**MULTIPOSTO**  
MULTIPIUESTOS  
MULTIPOSTE  
BENCH

**MESAS DE REUNIÃO**  
MESAS DE JUNTAS  
TABLE DE RÉUNION  
MEETING TABLE

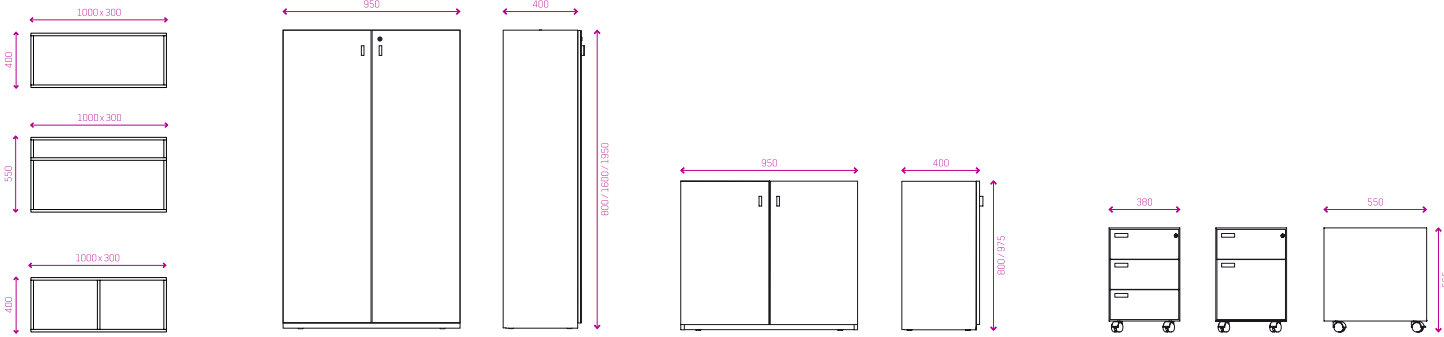

**BOX MULTIPOSTO**  
BOX MULTIPIUESTO  
BOX MULTIPOSTE  
BENCH BOX

**ARMÁRIO ALTO**  
ARMÁRIO ALTO  
ARMOIRE HAUTE  
CABINET

**ARMÁRIO BAIXO**  
ARMÁRIO BAIXO  
ARMOIRE BASSE  
SMALL CABINET

**BLOCO RODADO**  
CAJONERA RODANTE  
CAISSON SUR ROULETTES  
DRAWER UNIT ON CASTERS

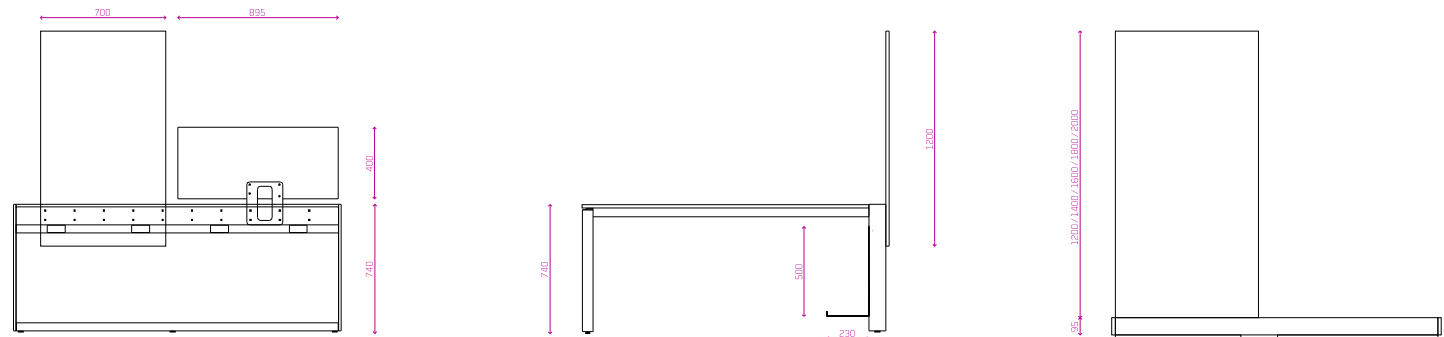

**BIOMBO CENTRAL**  
PANTALLA CENTRAL  
ÉCRAN CENTRAL  
CENTRAL SCREEN

**MESA DE CENTRO**  
MESA DE CENTRO  
TABLE BASSE  
SIDE TABLE

**SOFÁ**  
SOFÁ  
CANAPÉ  
COUCH

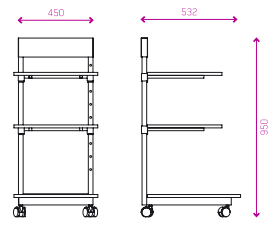

**MÓDULO PARA INFORMÁTICA**  
MÓDULO PARA INFORMÁTICA  
MODULE INFORMATIQUE  
COMPUTING MODULE

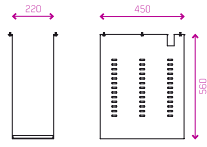

**PORTA CPU**  
SOPORTE PARA CPU  
PORTEUC  
CPU HOLDER

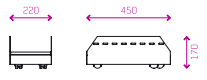

**PORTA CPU RODADO**  
SOPORTE PARA CPU CON RUEDAS  
PORTEUC À ROULETTES  
CPU HOLDER ON CASTER

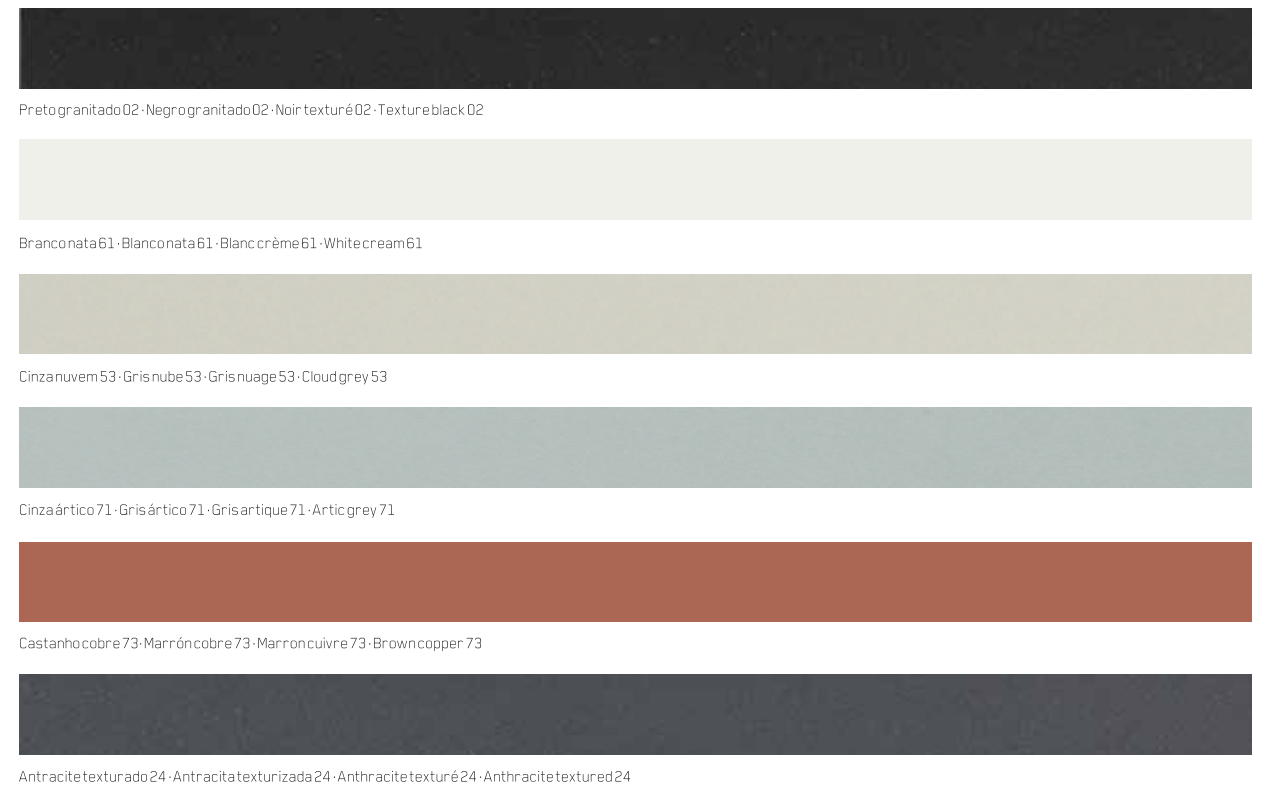

MELAMINAS / MELAMINAS / MELAMINÉS / MELAMINE

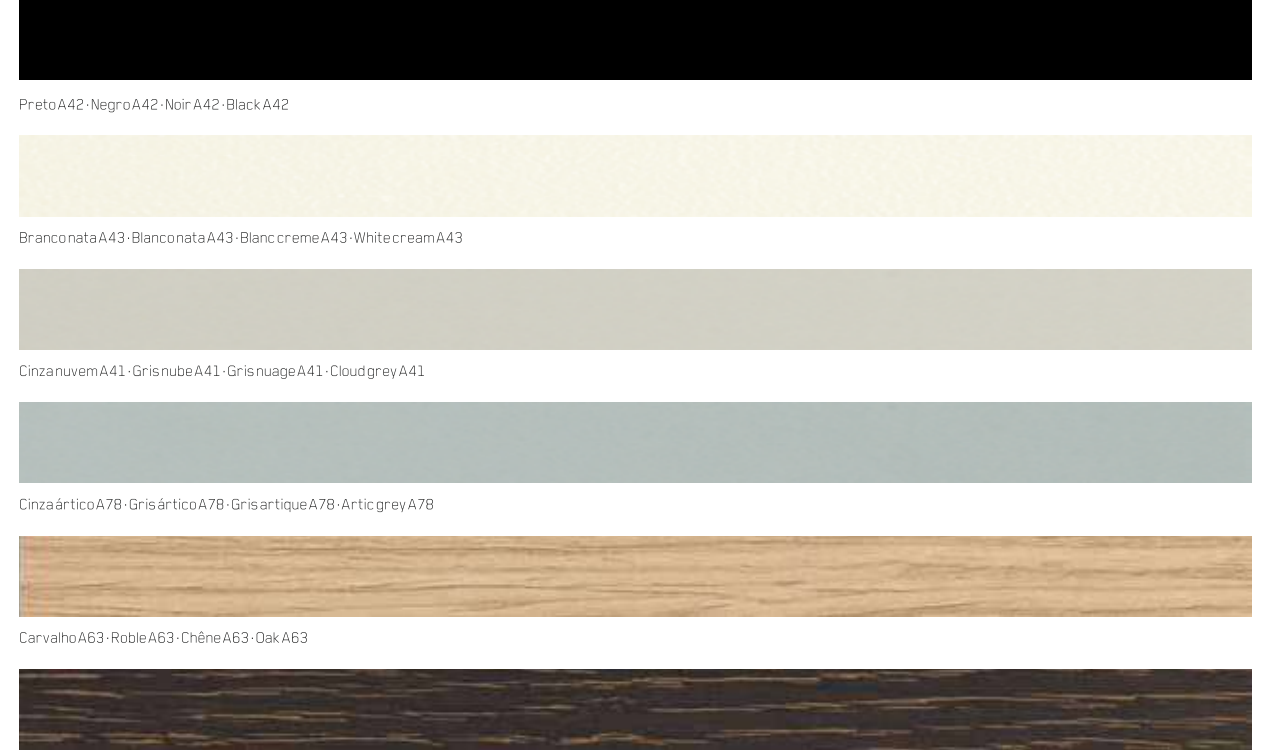

**sotuboi**

Sotubo Móveis Metálicos, S.A.

Rapadiça Revinhade  
4650-373 Felgueiras · Portugal  
T+351 255 340 770 · F+351 255 341 634  
[www.sotubo.com](http://www.sotubo.com) · [sotubo@sotubo.pt](mailto:sotubo@sotubo.pt)